

MOBILIÁRIOS

CÂMARA— ALMOXARIFADO E SALAS

MAYRA SANTOS
PROJETO EXECUTIVO
DETALHAMENTO DE MARCENARIAS



14 UNIDADES ARQUIVOS

CÂMARA— ALMOXARIFADO E SALAS



34 UNIDADES ESTANTES

MDFS UTILIZADOS:



MDF DURATEX
CALACATA GOLD



MDF DURATEX
GIANDUIA NATURAL
LINHA VELLUTO



MDF DURATEX
CARVALHO HANOVER



OBS: em todas as mesas de atendimentos tem furo para cabeamento

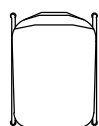

8 CADEIRAS

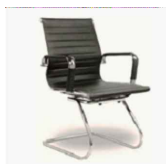

1 CADEIRA

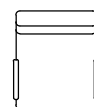

6 CADEIRAS



2 CADEIRAS



7 LIXEIRAS



CADEIRAS E MÓVEIS SUGERIDOS E SUAS QUANTIDADES SERÁ ENVIADO NO MEMORIAL DESCRITIVO

MESA NO MDF DURATEX
CARVALHO HANOVER
COM PÉS DE ESTRUTURA
METÁLICA PRETO

MESA NO MDF DURATEX
CARVALHO HANOVER
COM PÉS DE ESTRUTURA
METÁLICA PRETO

MESA NO MDF DURATEX
CARVALHO HANOVER
COM PÉS DE ESTRUTURA
METÁLICA PRETO

ARMÁRIOS ARQUIVOS
PASTA SUSPensa

PRATELEIRAS NO MDF DURATEX
CARVALHO HANOVER
COM ESTRUTURA METÁLICA
PRETO H=160cm DO PISO

MESA NO MDF DURATEX
CARVALHO HANOVER
COM PÉS DE ESTRUTURA
METÁLICA PRETO

BALCÃO EM MDF
DURATEX GALACATA
GOLD

4 ESTAÇÕES EXISTENTES
OBS: RETIRAR UMA ESTAÇÃO

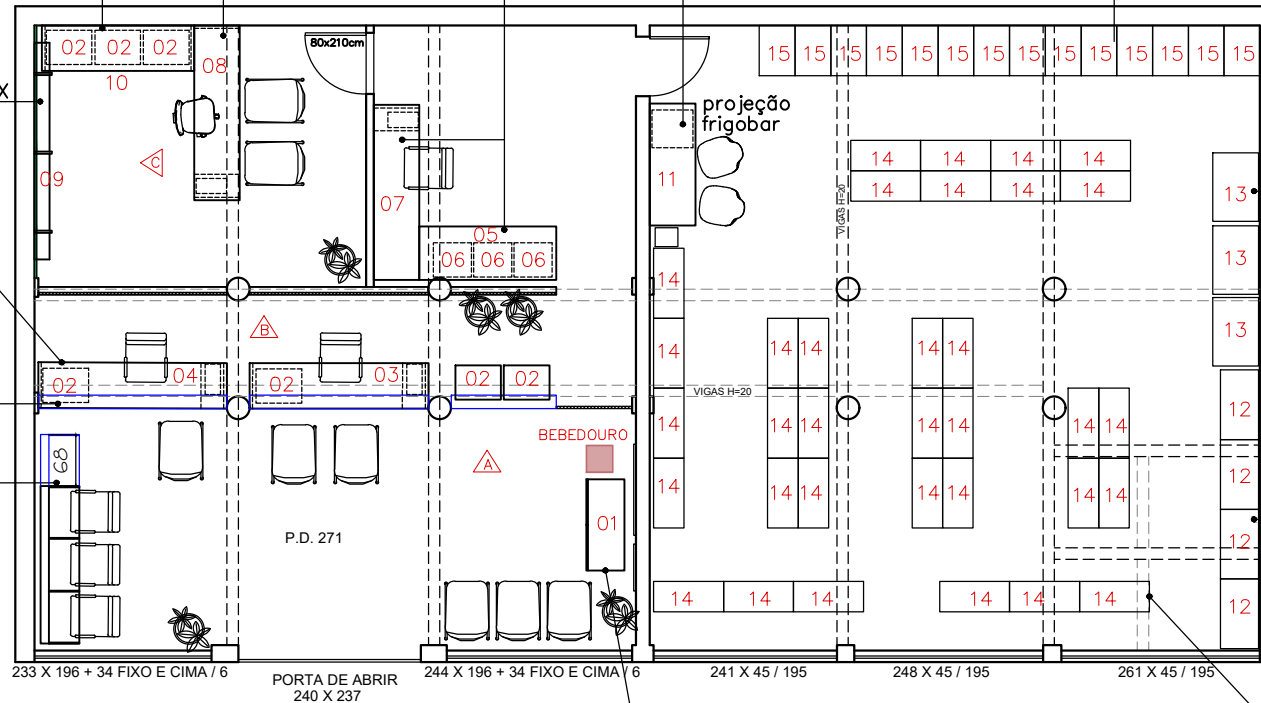

ARMÁRIOS COM
2 PORTAS DE ABRIR
NO MDF DURATEX
GIANDUIA NATURAL
LINHA VELLUTO

ESTANTES COM
PRATELEIRAS
NO MDF DURATEX
GIANDUIA NATURAL
LINHA VELLUTO

ESTANTES EM
AÇO A COMPRAR
40x92x198cm
COR CINZA

PLANTA DE LAYOUT ESPECIFICAÇÕES
ESC. 1/100

MESA NO MDF DURATEX
CARVALHO HANOVER
COM PÉS DE ESTRUTURA
METÁLICA PRETO

PROJETO EXECUTIVO

OBSERVAÇÕES: CONFERIR MEDIDAS NO LOCAL.

PROJETO: CÂMARA- ALMOXARIFADO

01/16

JUNHO / 2024

ARQUITETA: MAYRA SANTOS

LEGENDA TINTA PAREDE

 PAREDE PINTADA NA TINTA SUVINIL COR ÁGUA PROFUNDA

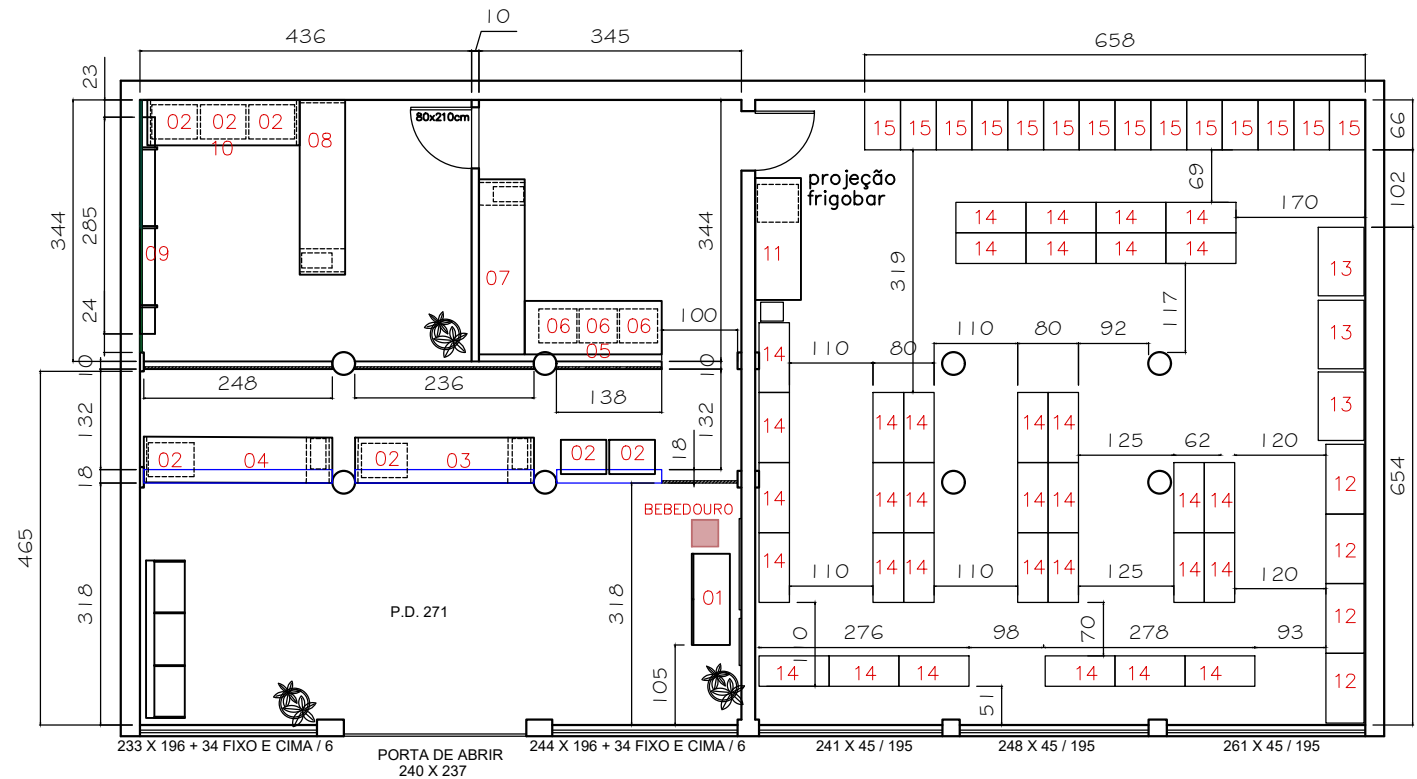

PLANTA DE LAYOUT COM MEDIDAS GERAIS ESC. 1/100

PROJETO EXECUTIVO _____

OBSERVAÇÕES: CONFERIR MEDIDAS NO LOCAL.

PROJETO: CÂMARA- ALMOXARIFADO

02/16

JUNHO / 2024

ARQUITETA: MAYRA SANTOS

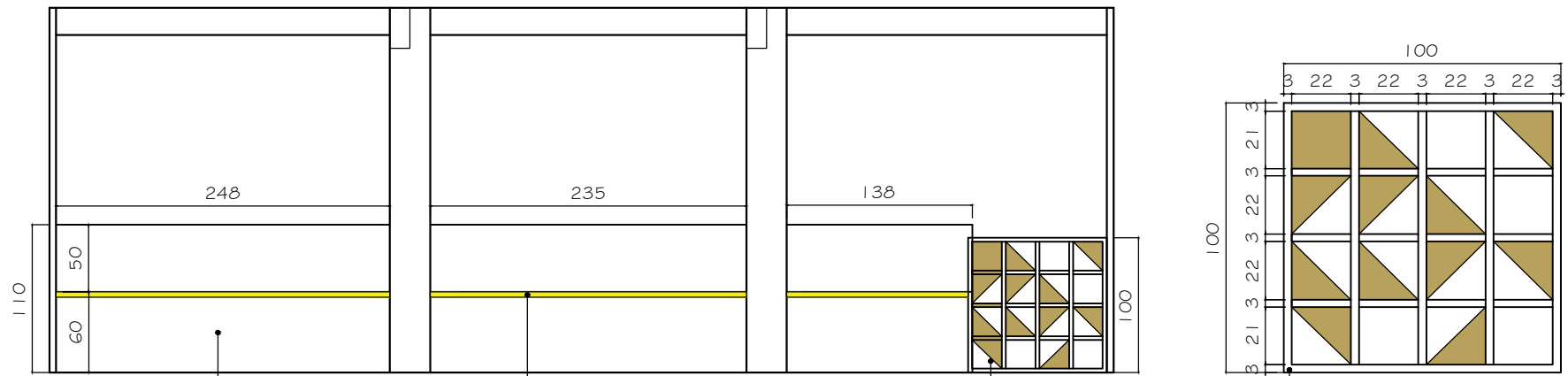

VISTA A
ESC. 1/50

BALCÃO NO MDF DURATEX
CALACATA GOLD
COM FITA DE LED EMBUTIDA

FITA DE
LED 2.700K

PORTÃO DE CORRER
NA ESTRUTURA METÁLICA 35X15
PRETA E MDF HANOVER
FAZENDO OS DETALHES
CORRE ATRÁS DO BALCÃO

DETALHE PORTÃO
ESC. 1/25



BALCÃO NO MDF DURATEX
CALACATA GOLD

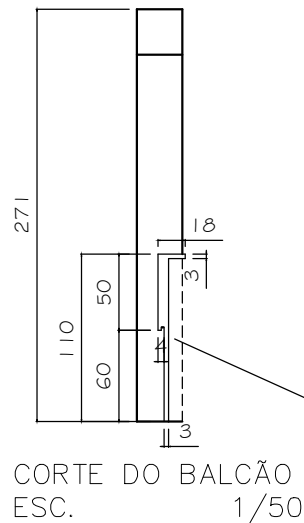

FITA DE LED EMBUTIDA
NA MARCENARIA 2.700K

FITA DE LED
ESC. 1/10

CORTE DO BALCÃO
ESC. 1/50

PROJETO EXECUTIVO

OBSERVAÇÕES: CONFERIR MEDIDAS NO LOCAL.

PROJETO: CÂMARA- ALMOXARIFADO

03/16

JUNHO / 2024

ARQUITETA: MAYRA SANTOS

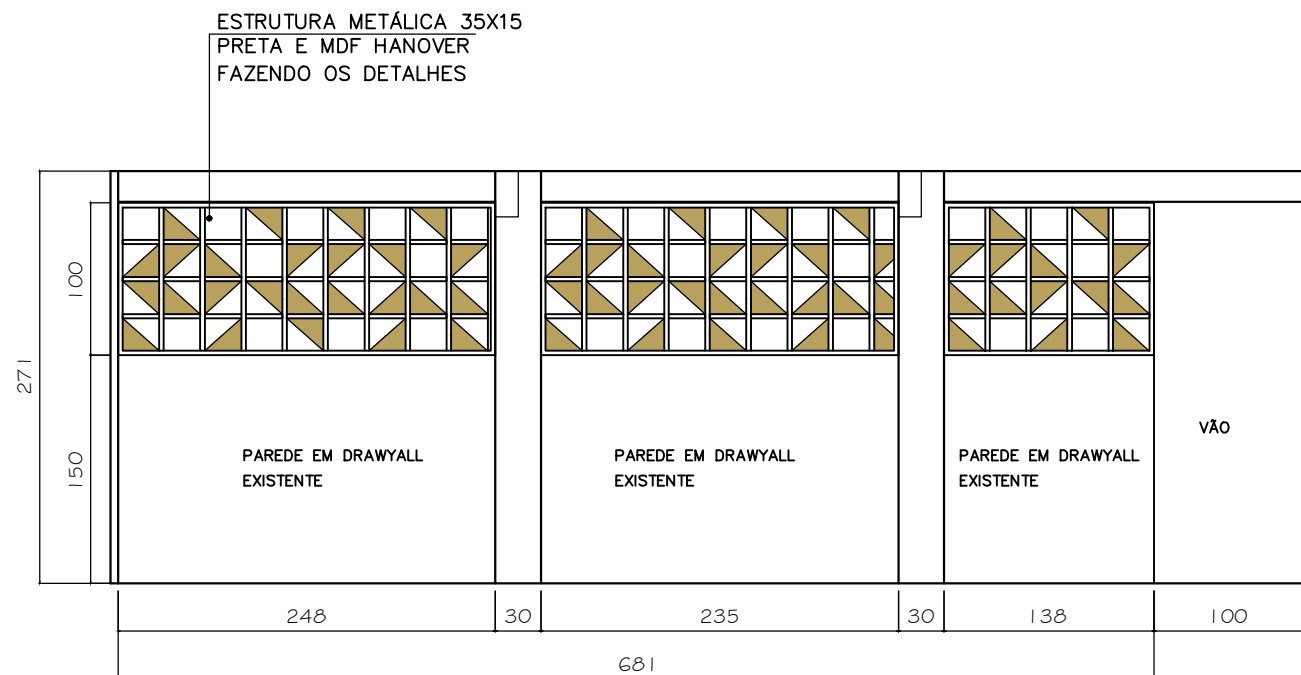

VISTA B
ESC. 1/50

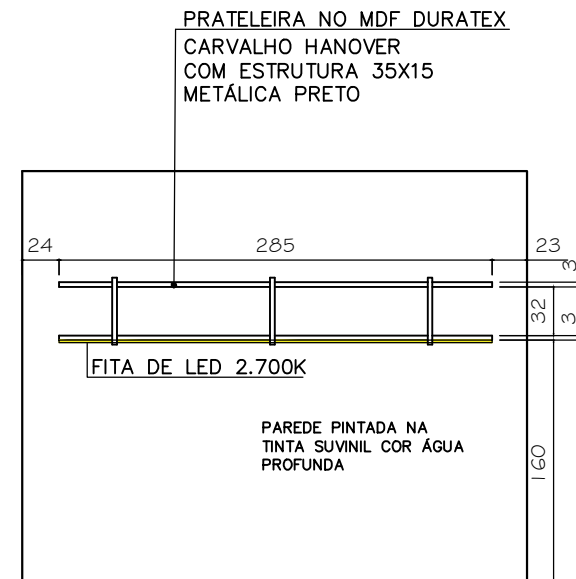

VISTA C
ESC. 1/50

LEGENDA TINTA PAREDE



PAREDE PINTADA NA
TINTA SUVINIL COR ÁGUA
PROFUNDA

01

MESA NO MDF DURATEX
CARVALHO HANOVER
COM PÉS DE ESTRUTURA 30X50
METÁLICA PRETO

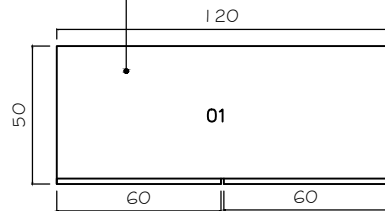

PLANTA MESA DO CAFÉ
ESC. 1/25

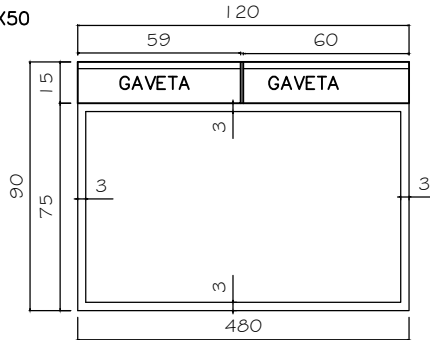

MESA FRONTAL
ESC. 1/25

PUXADOR CAVA
ESC. 1/10

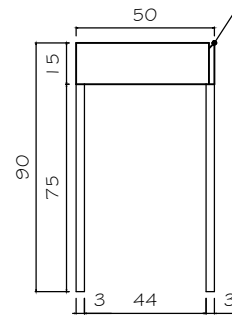
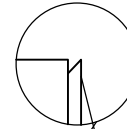

MESA LATERAL
ESC. 1/25

PUXADOR
NO PRÓPRIO
MDF HANOVER



MESA DO CAFÉ
IMAGEM 3D - ILUSTRATIVA

02

GAVETEIRO NO MDF
DURATEX GIANDUIA NATURAL
LINHA VELLUTO
PUXADOR CAVA

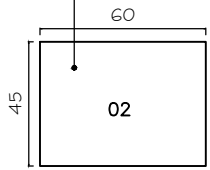

PLANTA GAVETEIRO
ESC. 1/25

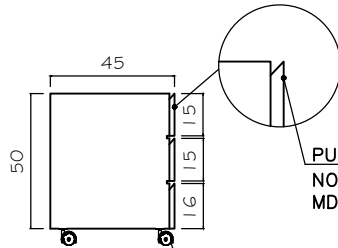

LATERAL GAVETEIRO
ESC. 1/25

PUXADOR
NO PRÓPRIO
MDF GIANDUIA

RODINHAS INCOLOR
OU PRETAS

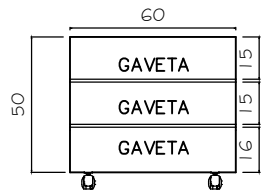

GAVETEIRO FRONTAL
ESC. 1/25

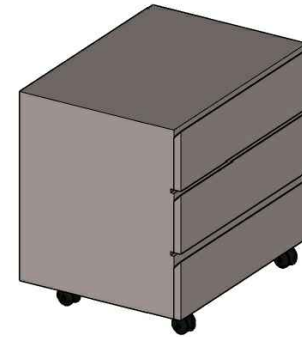

GAVETEIRO
IMAGENS 3D - ILUSTRATIVAS

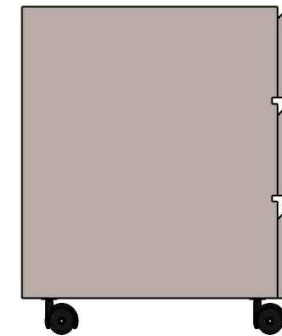

03

MESA NO MDF DURATEX
CARVALHO HANOVER
COM PÉS DE ESTRUTURA 30 X 50
METÁLICA PRETO

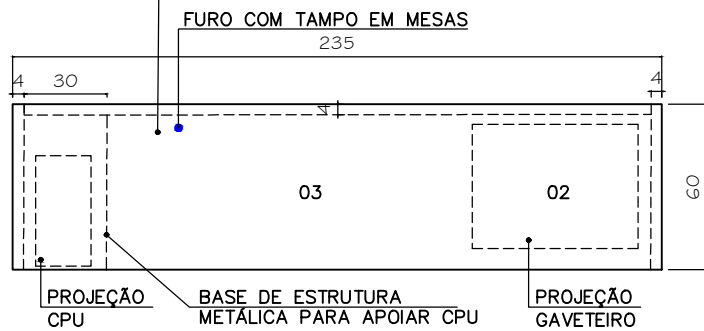

PLANTA MESA DE TRABALHO
ESC. 1/25

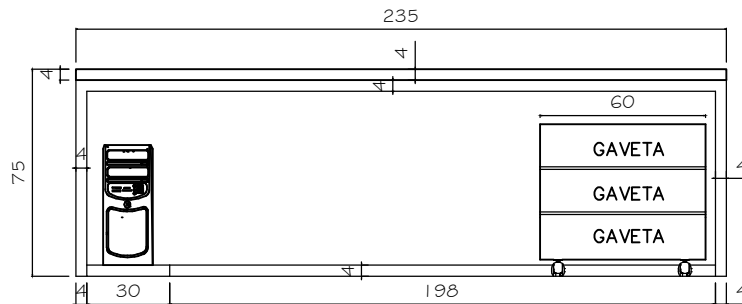

VISTA FRONTAL MESA DE TRABALHO
ESC. 1/25

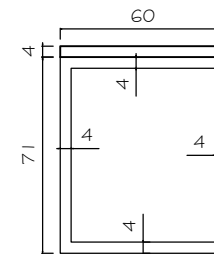

LATERAL DA MESA
ESC. 1/25



MESA DE TRABALHO
IMAGEM 3D – ILUSTRATIVA

07/16

JUNHO / 2024

ARQUITETA: MAYRA SANTOS

04

MESA NO MDF DURATEX
CARVALHO HANOVER
COM PÉS DE ESTRUTURA 30 X 50
METÁLICA PRETO

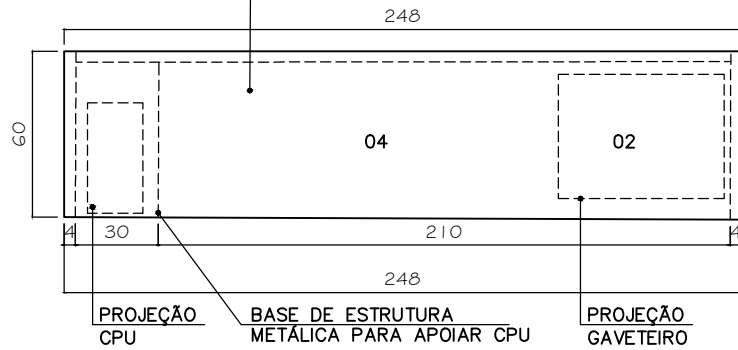

PLANTA MESA DE TRABALHO
ESC. 1/25

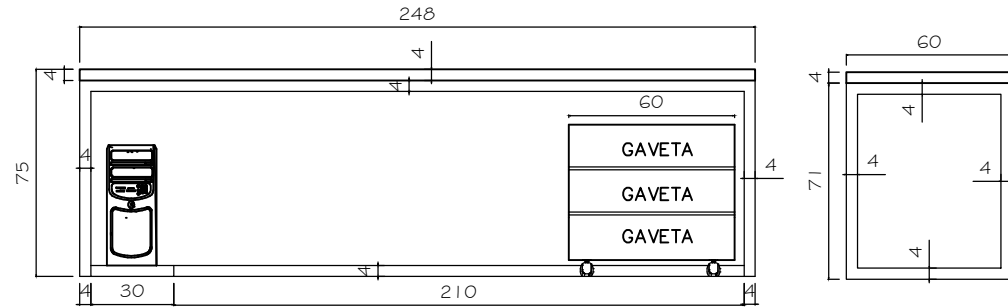

VISTA FRONTAL MESA DE TRABALHO
ESC. 1/25

LATERAL DA
MESA
ESC. 1/25



MESA DE TRABALHO
IMAGEM 3D – ILUSTRATIVA



08/16

JUNHO / 2024

ARQUITETA: MAYRA SANTOS

05

MESA NO MDF DURATEX
CARVALHO HANOVER
COM PÉS DE ESTRUTURA 30 X 50
METÁLICA PRETO

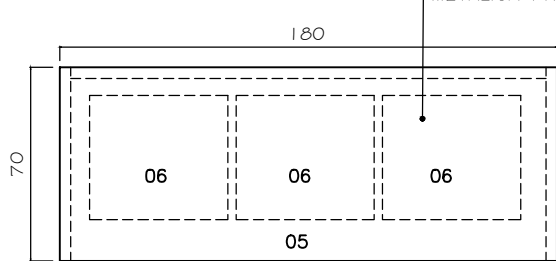

PLANTA MESA DE TRABALHO
ESC. 1/25

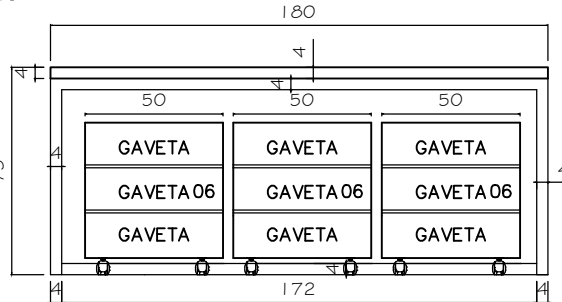

VISTA FRONTAL MESA DE TRABALHO
ESC. 1/25

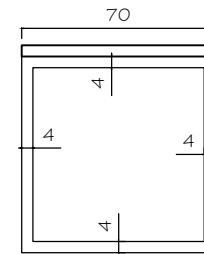

LATERAL DA
MESA
ESC. 1/25



MESA DE TRABALHO
IMAGEM 3D – ILUSTRATIVA

06

GAVETEIRO NO MDF
DURATEX GIANDUIA NATURAL
LINHA VELLUTO
PUXADOR CAVA

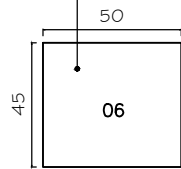

PLANTA GAVETEIRO
ESC. 1/25

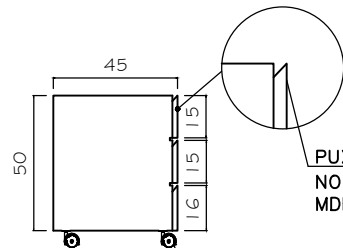

LATERAL GAVETEIRO
ESC. 1/25

PUXADOR
NO PRÓPRIO
MDF GIANDUIA

RODINHAS INCOLOR
OU PRETAS

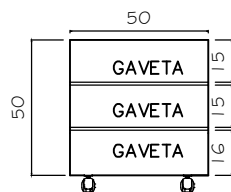

GAVETEIRO FRONTAL
ESC. 1/25

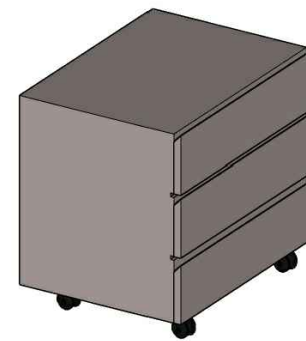

GAVETEIRO
IMAGENS 3D – ILUSTRATIVA

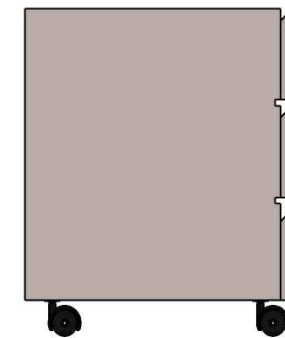

09/16

JUNHO / 2024

ARQUITETA: MAYRA SANTOS

07

FURO COM TAMPO EM MESAS

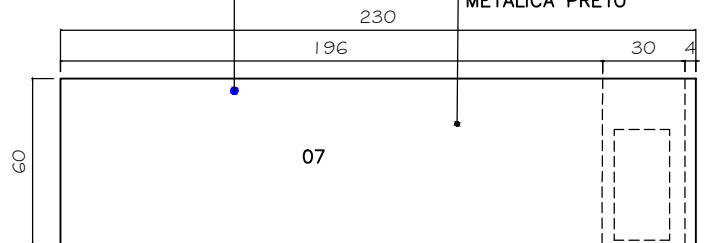

MESA NO MDF DURATEX
CARVALHO HANOVER
COM PÉS DE ESTRUTURA 30 X 50
METÁLICA PRETO

PLANTA MESA DE TRABALHO
ESC. 1/25

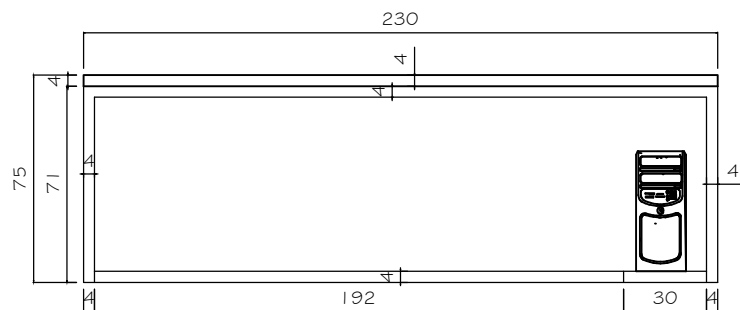

VISTA FRONTAL MESA DE TRABALHO
ESC. 1/25



MESA DE TRABALHO
IMAGEM 3D - ILUSTRATIVA

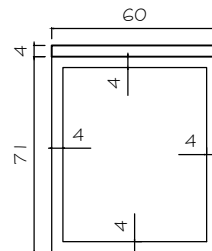

LATERAL DA
MESA
ESC. 1/25

08

FURO COM TAMPO EM MESAS

MESA NO MDF DURATEX
CARVALHO HANOVER
COM PÉS DE ESTRUTURA 30 X 50
METÁLICA PRETO

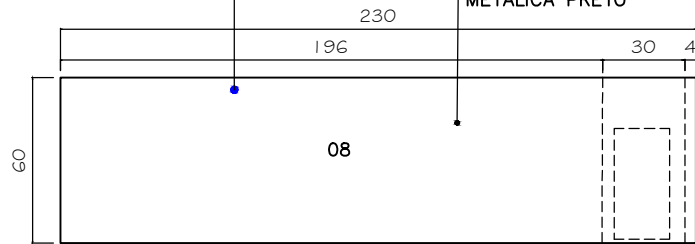

PLANTA MESA DE TRABALHO
ESC. 1/25



VISTA FRONTAL MESA DE TRABALHO
ESC. 1/25



MESA DE TRABALHO
IMAGEM 3D – ILUSTRATIVA

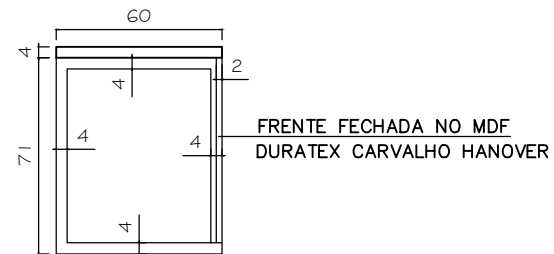

LATERAL DA
MESA
ESC. 1/25

09

PRATELEIRA NO MDF DURATEX
CARVALHO HANOVER
COM ESTRUTURA 35 X 15
METÁLICA PRETO

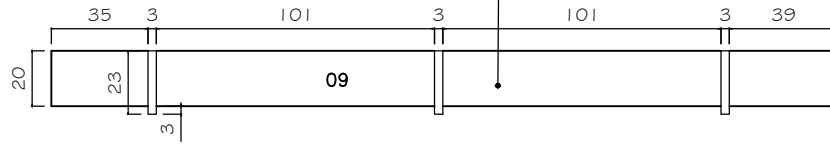

PLANTA PRATELEIRA SUSPENSA
ESC. 1/25

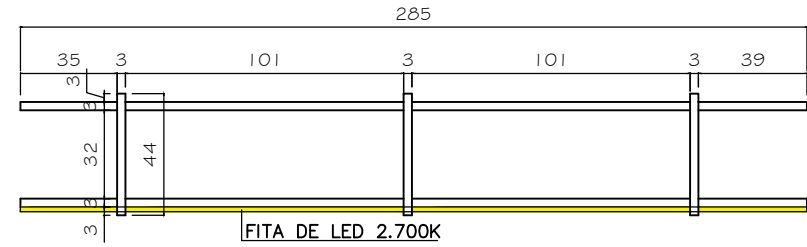

VISTA FRONTAL PRATELEIRA SUSPENSA
ESC. 1/25



FITA DE LED 2.700K
EMBUTIDA NA PRATELEIRA



FITA DE LED DA PRATELEIRA
ESC. 1/5

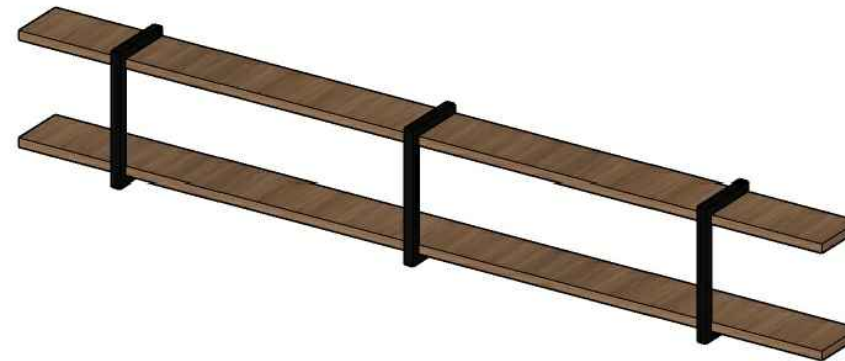

PRATELEIRAS SUSPENSAS
IMAGEM 3D – ILUSTRATIVA

10

COM ESTRUTURA 30 X 50 METÁLICA PRETO

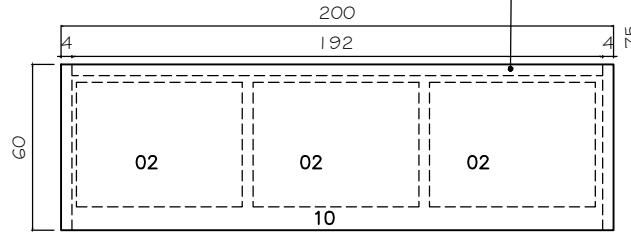

PLANTA MESA DE TRABALHO ESC. 1/25

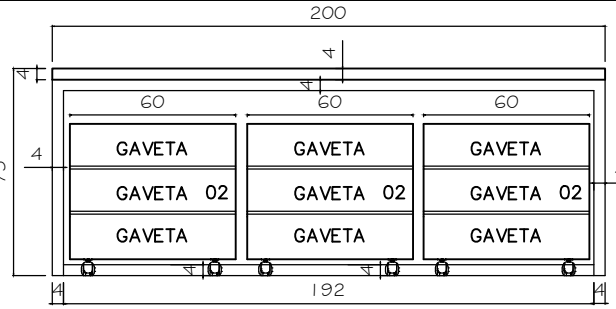

VISTA FRONTAL MESA ESC. 1/25

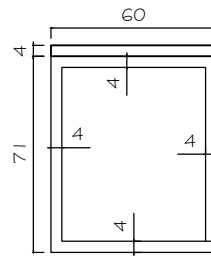

LATERAL DA MESA ESC. 1/25



MESA DE TRABALHO IMAGEM 3D – ILUSTRATIVA

02

GAVETEIRO NO MDF DURATEX GIANDUIA NATURAL LINHA VELLUTO PUXADOR CAVA

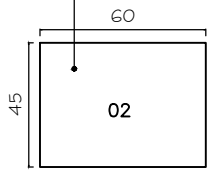

PLANTA GAVETEIRO ESC. 1/25

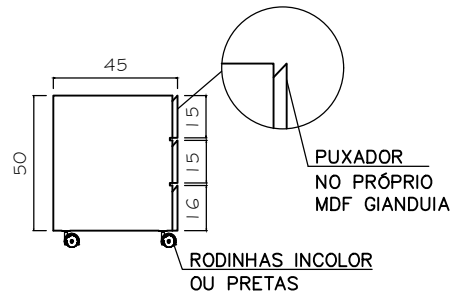

LATERAL GAVETEIRO ESC. 1/25

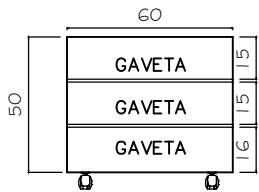

GAVETEIRO FRONTAL ESC. 1/25

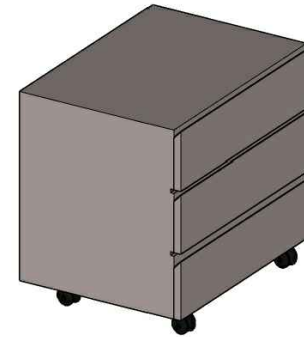

GAVETEIRO IMAGENS 3D – ILUSTRATIVA

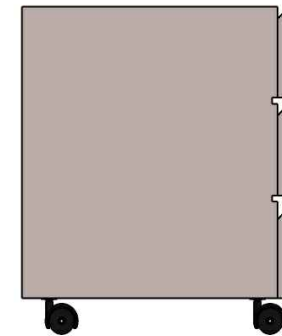

11

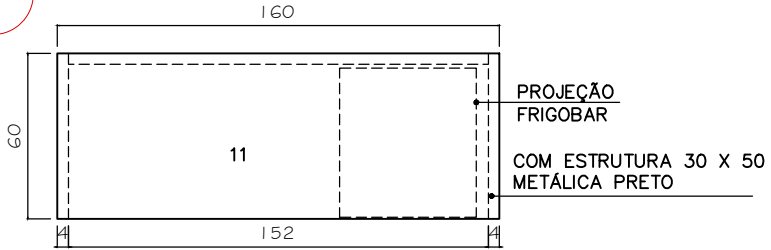

PLANTA MESA DE CAFÉ E ÁGUA ESC. 1/25

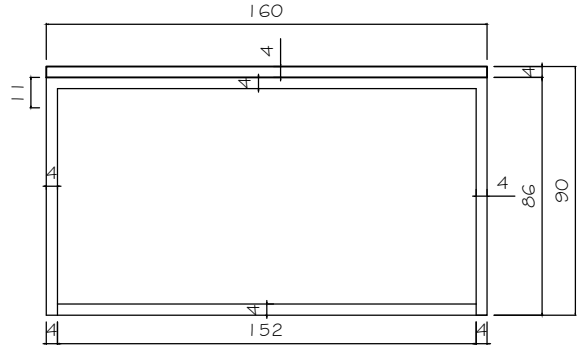

VISTA FRONTAL MESA ESC. 1/25

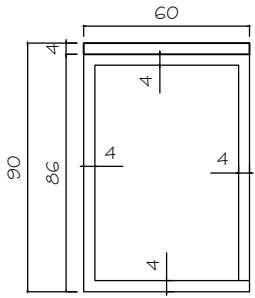

LATERAL DA MESA ESC. 1/25



SUGESTÃO DE FRIGOBAR marca electrolux voltagem 110



MESA DE CAFÉ E ÁGUA IMAGEM 3D – ILUSTRATIVA

12

ESTANTE COM PRATELEIRAS
NO MDF DURATEX GIANDUIA
NATURAL LINHA VELLUTO

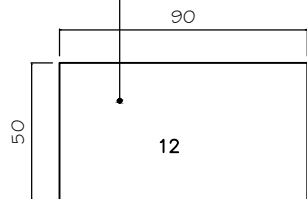

PLANTA ESTANTE
ESC. 1/25

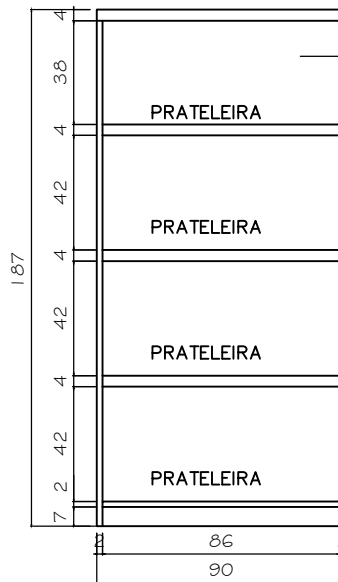

FUNDO NO MDF
DURATEX GIANDUIA
NATURAL LINHA VELLUTO

FRENTE ESTANTE
ESC. 1/25



ESTANTE COISAS PAPELARIA
IMAGEM 3D – ILUSTRATIVA

13

ARMÁRIO NO MDF
DURATEX GIANDUIA
NATURAL LINHA VELLUTO
PUXADOR CROMADO

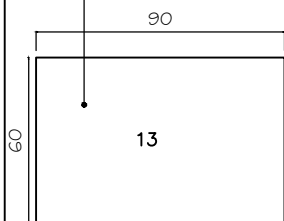

PLANTA ARMÁRIO
ESC. 1/25

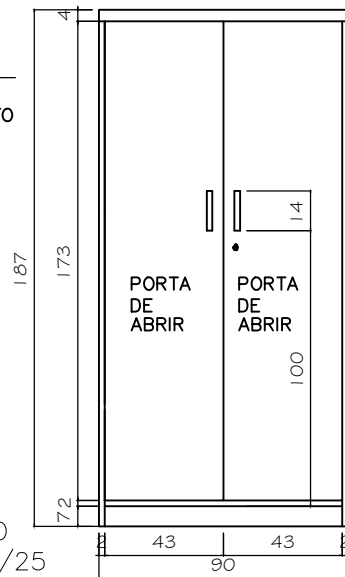

ARMÁRIO
ESC. 1/25

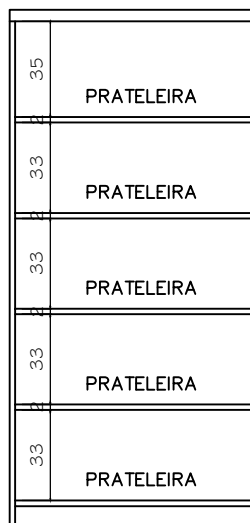

PARTE INTERNA ARMÁRIO
ESC. 1/25

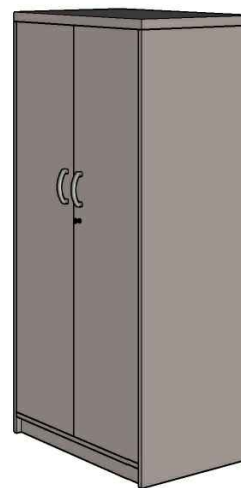

ARMÁRIO
IMAGEM 3D – ILUSTRATIVA



15/16

14

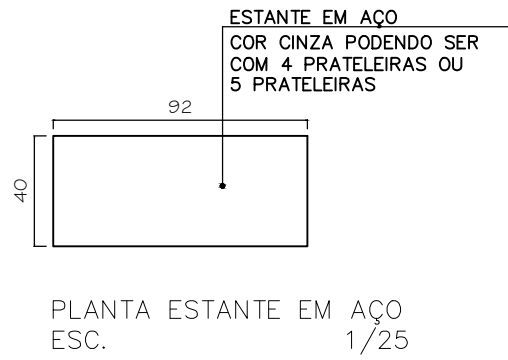

OBS: COMPRAR 34 UNIDADES
DE ACORDO COM SITE PARA COMPRAS

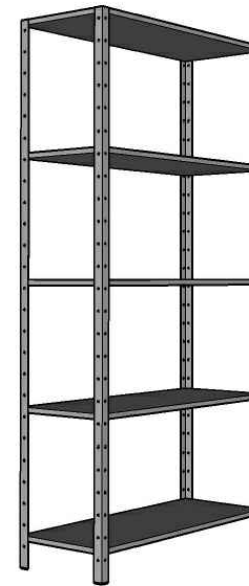
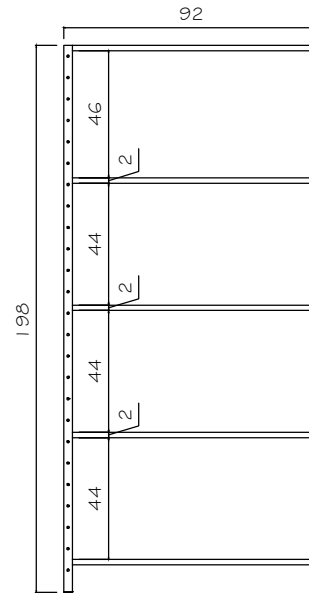

ESTANTE
IMAGEM 3D - ILUSTRATIVA

MAYRA SANTOS
PROJETO EXECUTIVO
DETALHAMENTO DE MARCENARIAS

CÂMARA- RECEPTÃO

MDFS UTILIZADOS: OBS: em todas a mesa de atendimento tem furo para cabeamento



MDF DURATEX
CARVALHO HANOVER

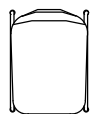

5 CADEIRAS



1 CADEIRAS

2 LIXEIRAS



CADEIRAS E MÓVEIS SUGERIDOS E SUAS QUANTIDADES SERÁ ENVIADO NO MEMORIAL DESCRITIVO

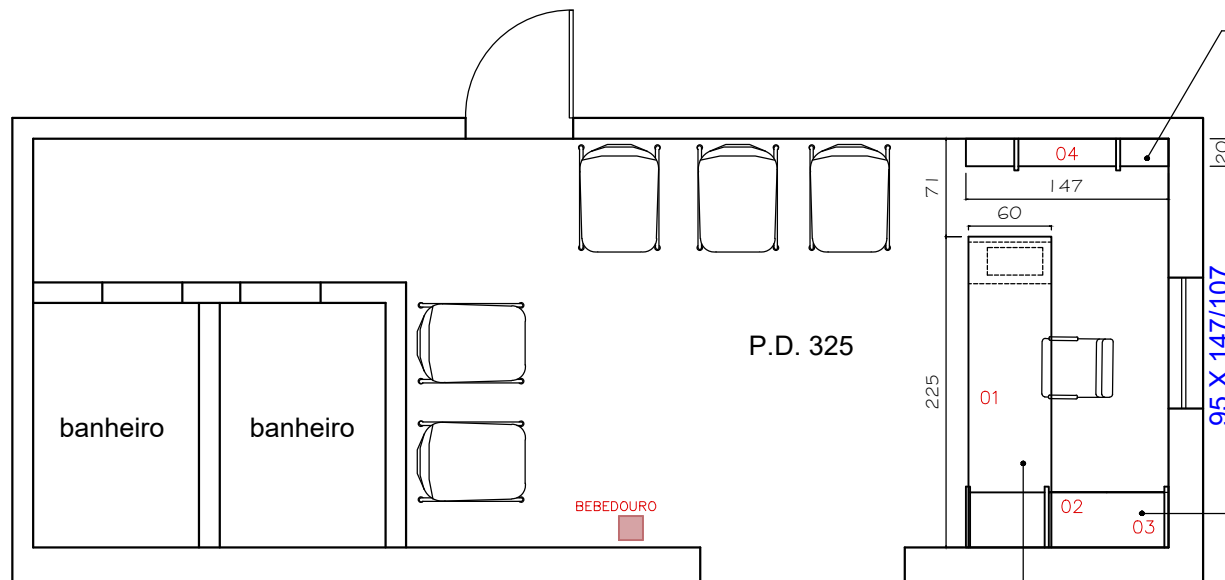

PRATELEIRA NO MDF DURATEX
 CARVALHO HANOVER
 COM ESTRUTURA
 METÁLICA PRETO
 H=160cm DO PISO

95 X 147/107

ARMÁRIO NO MDF DURATEX
 CARVALHO HANOVER
 COM ESTRUTURA 35X15
 METÁLICA PRETO
 H=160cm DO PISO

MESA NO MDF DURATEX
 CARVALHO HANOVER
 COM PÉS DE ESTRUTURA 30X50
 METÁLICA PRETO

PLANTA DE LAYOUT ESPECIFICAÇÕES
 ESC. 1/100

PROJETO EXECUTIVO

OBSERVAÇÕES: CONFERIR MEDIDAS NO LOCAL.

PROJETO: CÂMARA-RECEPÇÃO

01/05

JUNHO / 2024

ARQUITETA: MAYRA SANTOS

01

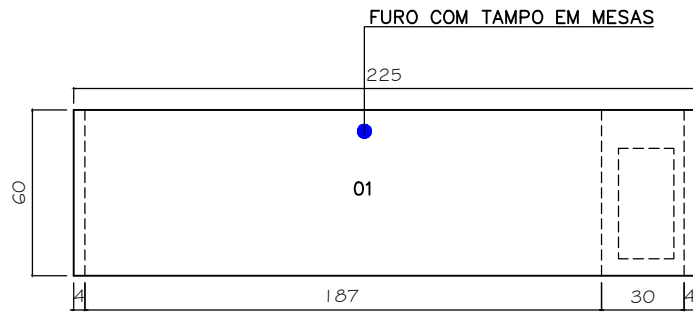

PLANTA MESA
ESC. 1/25

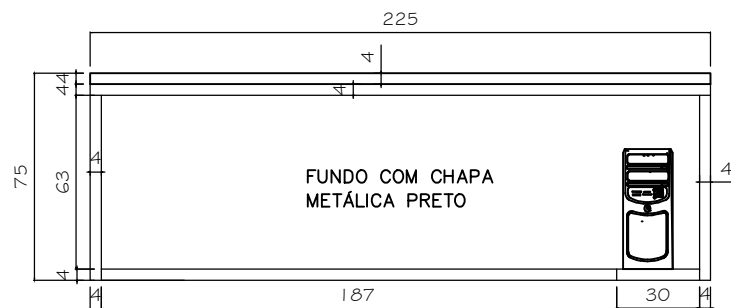

VISTA FRONTAL MESA
ESC. 1/25



MESA DE TRABALHO
IMAGEM 3D – ILUSTRATIVA

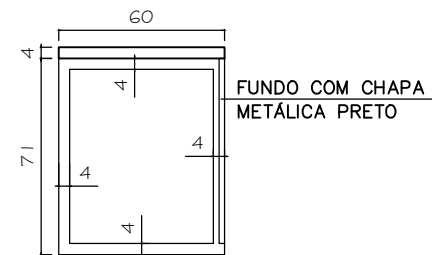

LATERAL DA
MESA
ESC. 1/25

PROJETO EXECUTIVO

OBSERVAÇÕES: CONFERIR MEDIDAS NO LOCAL.

PROJETO: CÂMARA- RECEPTÃO

02/05

JUNHO / 2024

ARQUITETA: MAYRA SANTOS

02

ARMÁRIO NO MDF DURATEX
CARVALHO HANOVER
PUXADOR CAVA

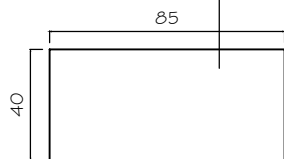

PLANTA ARMÁRIO
ESC. 1/25

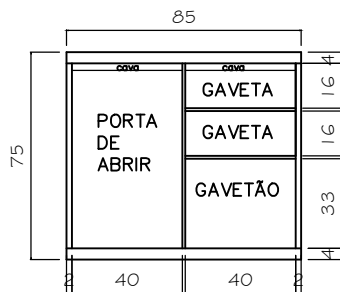

VISTA FRONTAL ARMÁRIO
ESC. 1/25

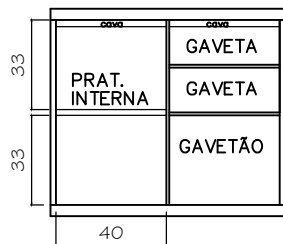

PARTE INTERNA
ESC. 1/25



ARMÁRIO
IMAGEM 3D – ILUSTRATIVA

PROJETO EXECUTIVO

OBSERVAÇÕES: CONFERIR MEDIDAS NO LOCAL.

PROJETO: CÂMARA- RECEPÇÃO

03/05

JUNHO / 2024

ARQUITETA: MAYRA SANTOS

03

ARMÁRIO NO MDF DURATEX
CARVALHO HANOVER
COM ESTRUTURA 35X15
METÁLICA PRETO
H=160cm DO PISO

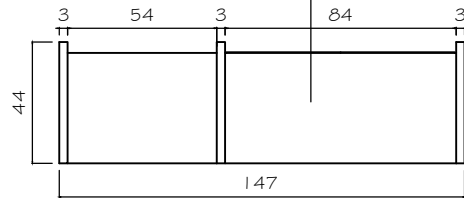

PLANTA ARMÁRIO SUSPENSO
ESC. 1/25

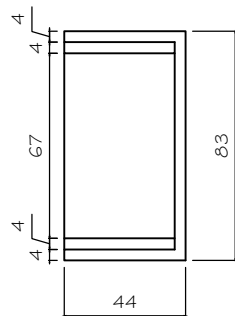

LATERAL ARMÁRIO
ESC. 1/25

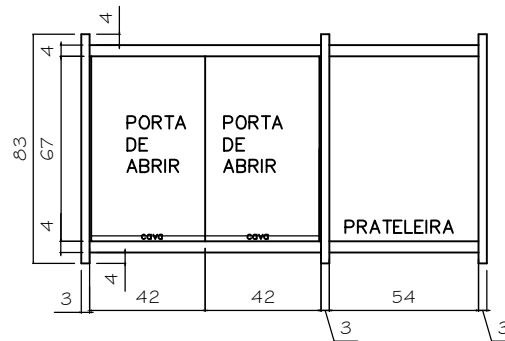

VISTA FRONTAL ARMÁRIO SUSPENSO
ESC. 1/25



ARMÁRIO SUSPENSO
IMAGEM 3D - ILUSTRATIVA

PROJETO EXECUTIVO

OBSERVAÇÕES: CONFERIR MEDIDAS NO LOCAL.

PROJETO: CÂMARA- RECEPTÃO

04/05

JUNHO / 2024

ARQUITETA: MAYRA SANTOS

04

PRATELEIRA NO MDF DURATEX
CARVALHO HANOVER
COM ESTRUTURA 35X15
METÁLICA PRETO
H=160cm DO PISO

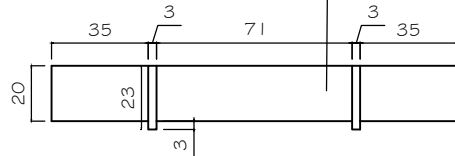

PLANTA PRATELEIRAS
ESC. 1/25

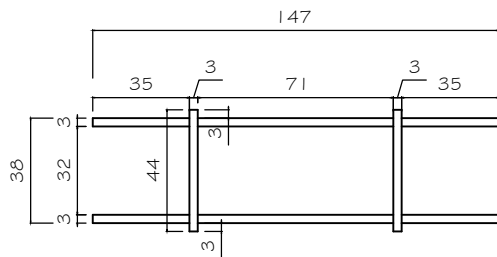

VISTA FRONTAL PRATELEIRAS
ESC. 1/25

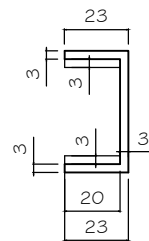

LATERAL PRATELEIRAS
ESC. 1/25



PRATELEIRAS SUSPENSAS
IMAGEM 3D – ILUSTRATIVA

PROJETO EXECUTIVO

OBSERVAÇÕES: CONFERIR MEDIDAS NO LOCAL.

PROJETO: CÂMARA – RECEPÇÃO

05/05

JUNHO / 2024

ARQUITETA: MAYRA SANTOS

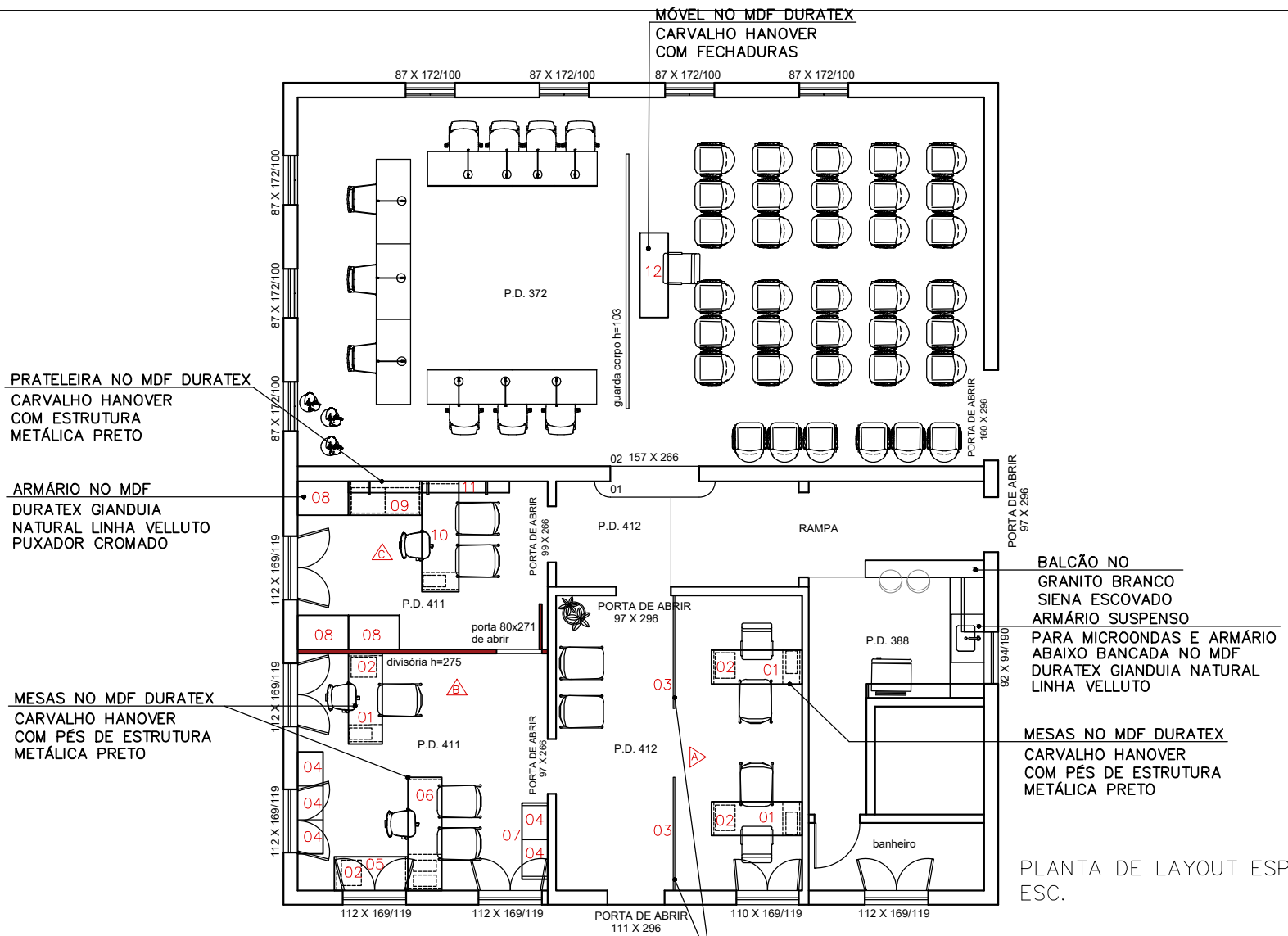

PLANTA DE LAYOUT ESPECIFICAÇÕES ESC. 1/100

PROJETO EXECUTIVO
 OBSERVAÇÕES: CONFERIR MEDIDAS NO LOCAL.
 PROJETO: CÂMARA- SEDE

DIVISÓRIA NA
 NA ESTRUTURA METÁLICA
 PRETA E MDF HANOVER
 FAZENDO OS DETALHES

01/15
 JUNHO / 2024
 ARQUITETA: MAYRA SANTOS

MAYRA SANTOS

PROJETO EXECUTIVO

DETALHAMENTO DE MARCENARIAS

CÂMARA – SEDE

MDFS UTILIZADOS:

OBS: em todas as mesas de atendimentos tem furo para cabeamento



MDF DURATEX
GIANDUIA NATURAL
LINHA VELLUTO

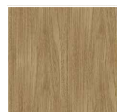

MDF DURATEX
CARVALHO HANOVER

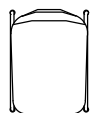

9 CADEIRAS



3 CADEIRAS



3 CADEIRAS

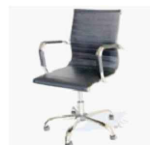

2 BANQUETAS



6 LIXEIRAS



CADEIRAS E MÓVEIS SUGERIDOS E SUAS QUANTIDADES SERÁ ENVIADO NO MEMORIAL DESCRITIVO

LEGENDA TINTA PAREDE



PAREDE PINTADA NA
TINTA SUVINIL COR ÁGUA
PROFUNDA

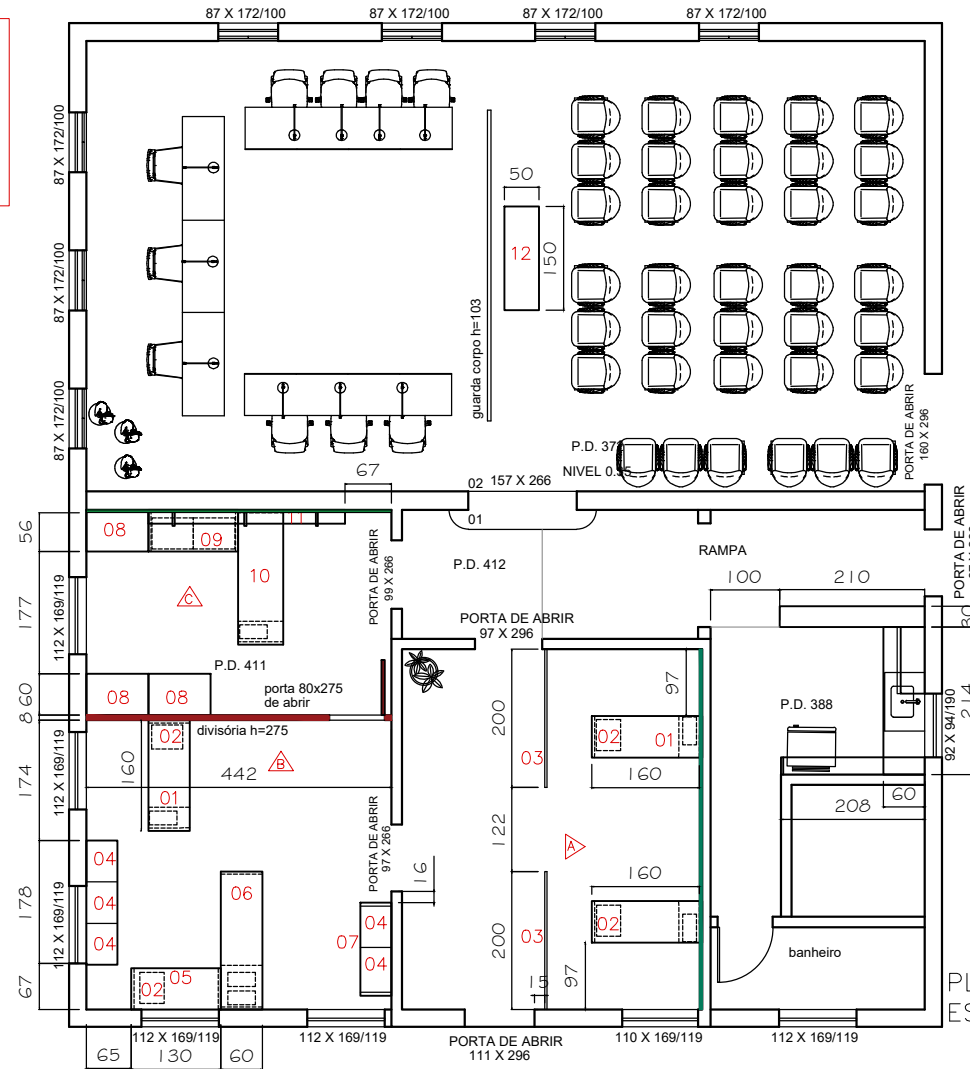

PLANTA MEDIDAS GERAIS
ESC. 1/100

PROJETO EXECUTIVO

OBSERVAÇÕES: CONFERIR MEDIDAS NO LOCAL.

PROJETO: CÂMARA- SEDE

02/15

JUNHO / 2024

ARQUITETA: MAYRA SANTOS

01

FURO COM TAMPO EM MESAS

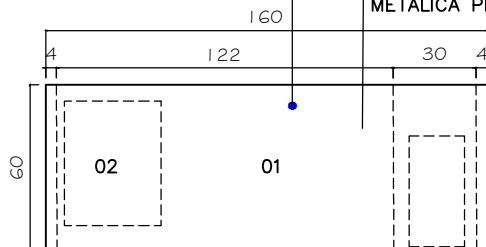

PLANTA MESA
ESC. 1/25

FUNDO COM CHAPA
METÁLICA PRETO

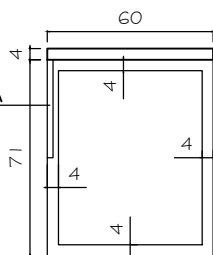

LATERAL DA
MESA
ESC. 1/25

MESA NO MDF DURATEX
CARVALHO HANOVER
COM PÉS DE ESTRUTURA 30X50
METÁLICA PRETO

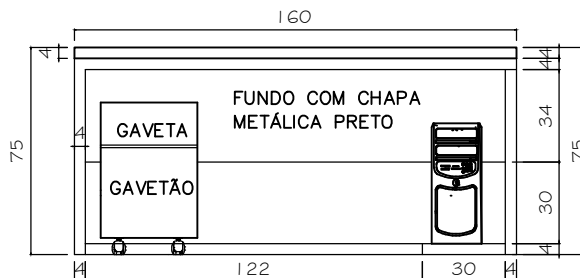

VISTA FRONTAL MESA
ESC. 1/25



MESA DE TRABALHO
IMAGEM 3D – ILUSTRATIVA

02

GAVETEIRO NO MDF
DURATEX GIANDUIA NATURAL
LINHA VELLUTO
PUXADOR CAVA

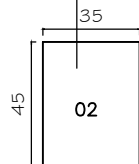

PLANTA GAVETEIRO
ESC. 1/25

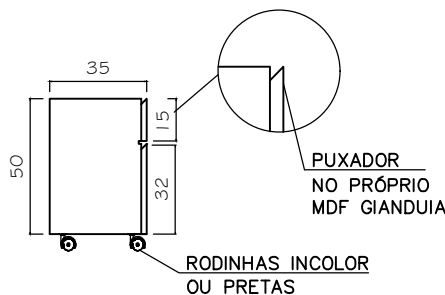

LATERAL GAVETEIRO
ESC. 1/25

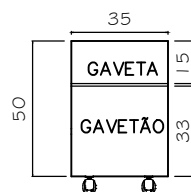

GAVETEIRO FRONTAL
ESC. 1/25

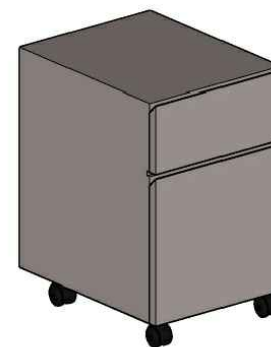

GAVETEIRO
IMAGEM 3D – ILUSTRATIVA

03/15

JUNHO / 2024

ARQUITETA: MAYRA SANTOS

03

DIVISÓRIA NA
NA ESTRUTURA METÁLICA 30X50
PRETA E MDF HANOVER
FAZENDO OS DETALHES

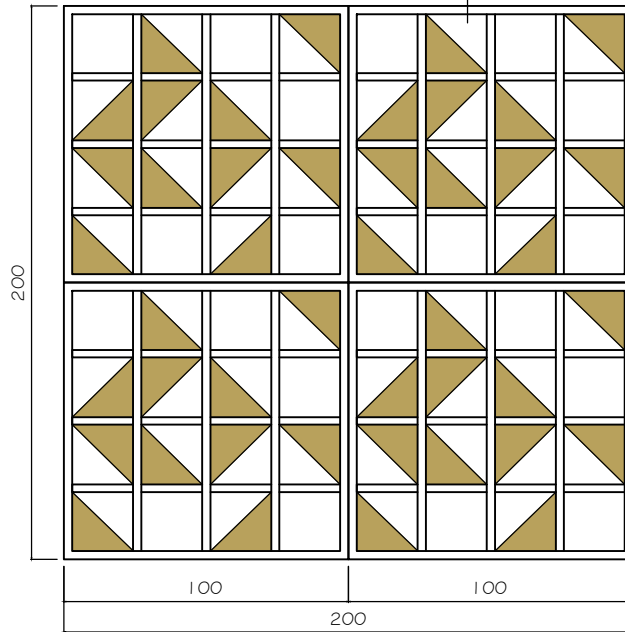

DIVISÓRIA JUNTAS
ESC. 1/25

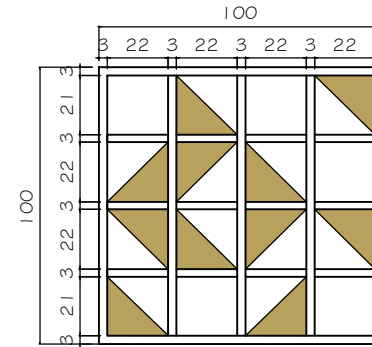

DETALHE DA DIVISÓRIA
ESC. 1/25



IMAGEM 3D – ILUSTRATIVA



04/15

VISTA PAREDE RECEPÇÃO – SEDE

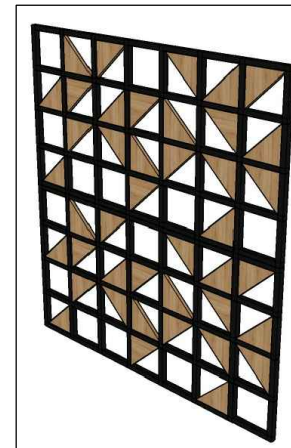
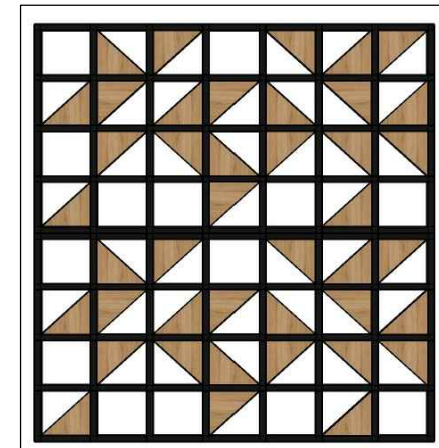
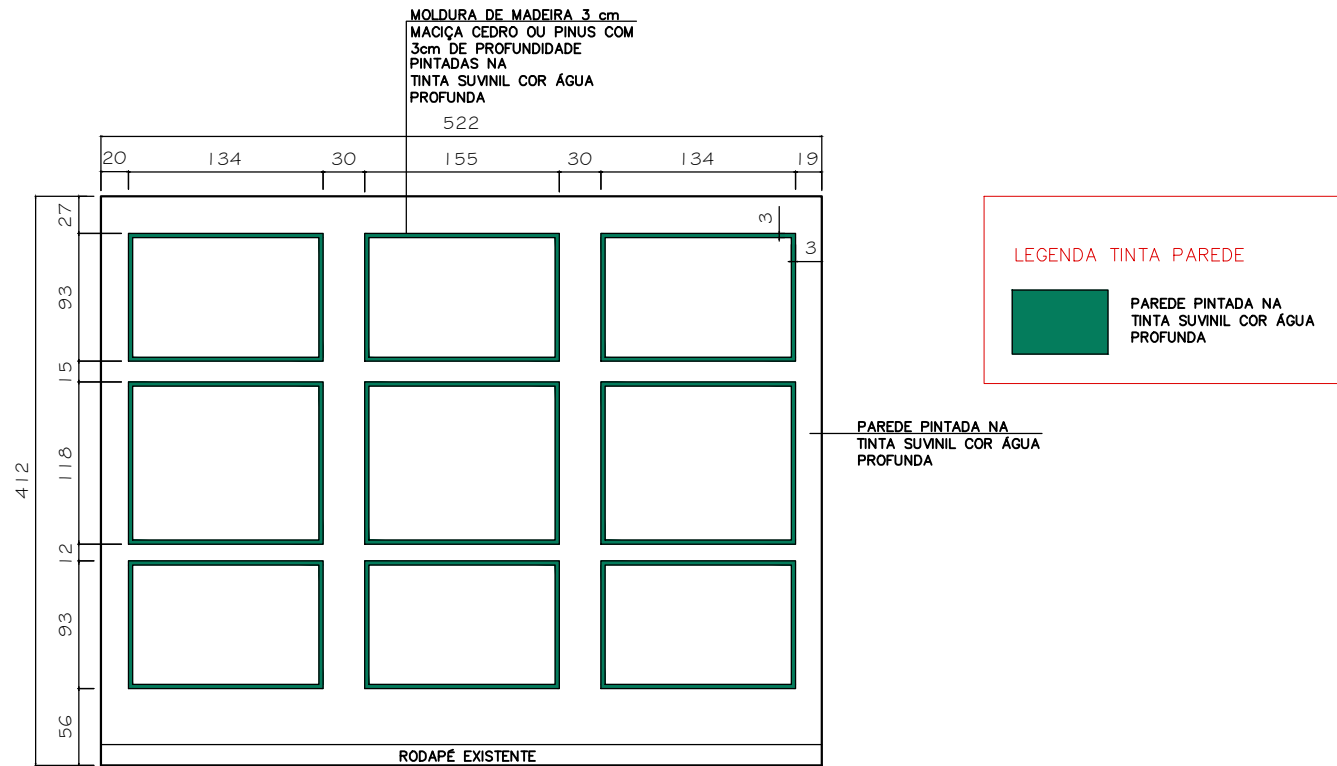

VISTA A
ESC. 1/50

05/15

JUNHO / 2024

ARQUITETA: MAYRA SANTOS

04

CARRINHO COM 2 PORTAS DE ABRIR
NO MDF DURATEX GIANDUIA NATURAL
LINHA VELLUTO
PUXADOR CAVA

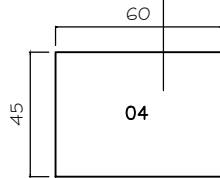

PLANTA CARRINHO
ESC. 1/25

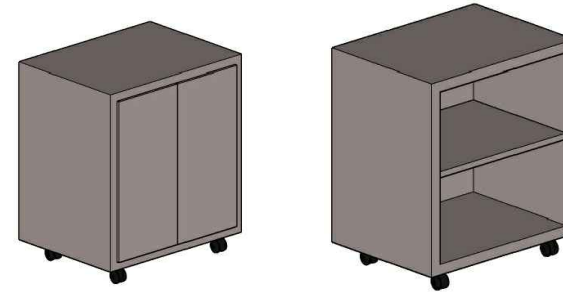
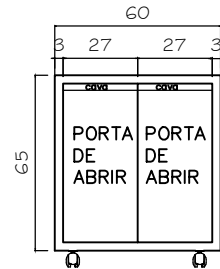

CARRINHO COM 2 PORTAS
IMAGEM 3D – ILUSTRATIVA

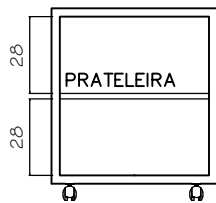

PARTE INTERNA
ESC. 1/25

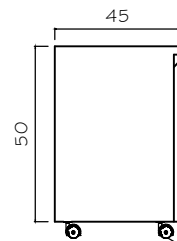

LATERAL CARRINHO
ESC. 1/25

RODINHAS INCOLOR
OU PRETAS

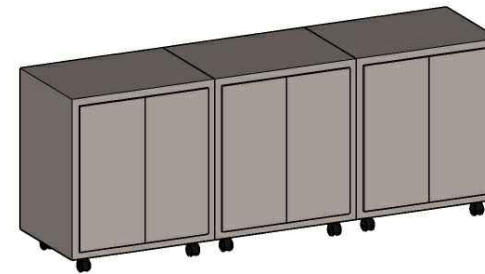

CARRINHO JUNTOS COM 2 PORTAS
IMAGEM 3D – ILUSTRATIVA

05

MESA NO MDF DURATEX
CARVALHO HANOVER
COM PÉS DE ESTRUTURA 30X50
METÁLICA PRETO

FURO COM TAMPO EM MESAS

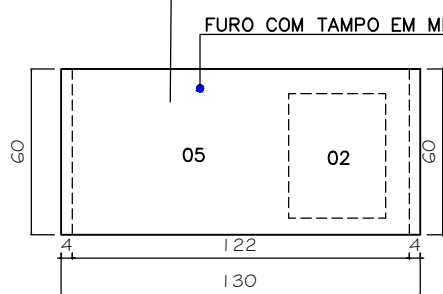

PLANTA MESA
ESC. 1/25

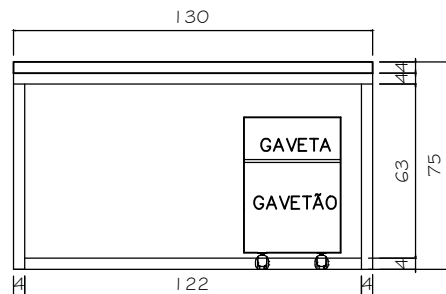

VISTA FRONTAL MESA
ESC. 1/25

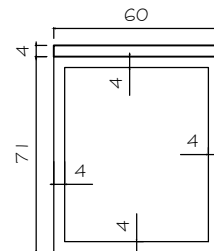

LATERAL DA
MESA
ESC. 1/25



MESA DE TRABALHO
IMAGEM 3D – ILUSTRATIVA

06

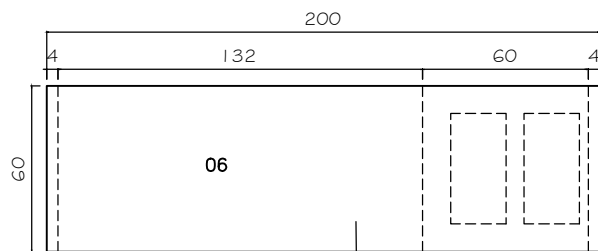

PLANTA MESA
ESC. 1/25

MESA NO MDF DURATEX
CARVALHO HANOVER
COM PÉS DE ESTRUTURA
METÁLICA PRETO

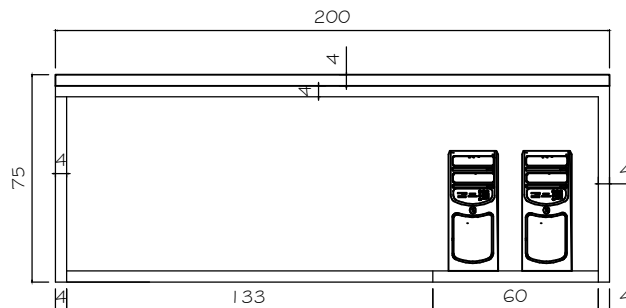

VISTA FRONTAL MESA
ESC. 1/25



MESA DE TRABALHO
IMAGEM 3D – ILUSTRATIVA

07/15

JUNHO / 2024

ARQUITETA: MAYRA SANTOS

07

APARADOR NO MDF DURATEX
CARVALHO HANOVER
COM 2 CARRINHOS DE
PORTAS NO MDF DURATEX
GIANDUIA LINHA VELLUTO
PUXADOR CAVA

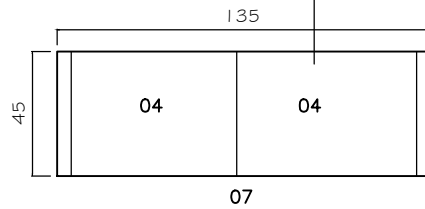

PLANTA APARADOR
ESC. 1/25

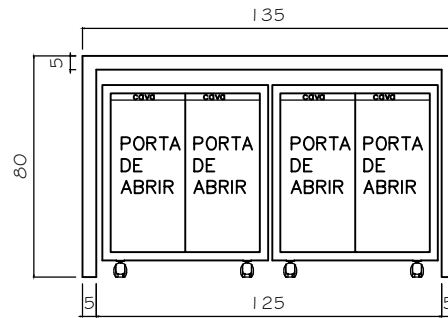

VISTA FRONTAL APARADOR
ESC. 1/25



APARADOR
IMAGEM 3D – ILUSTRATIVA

08/15

JUNHO / 2024

ARQUITETA: MAYRA SANTOS

VISTAS – DIVISÓRIA E PAREDE SALA LÍVIA

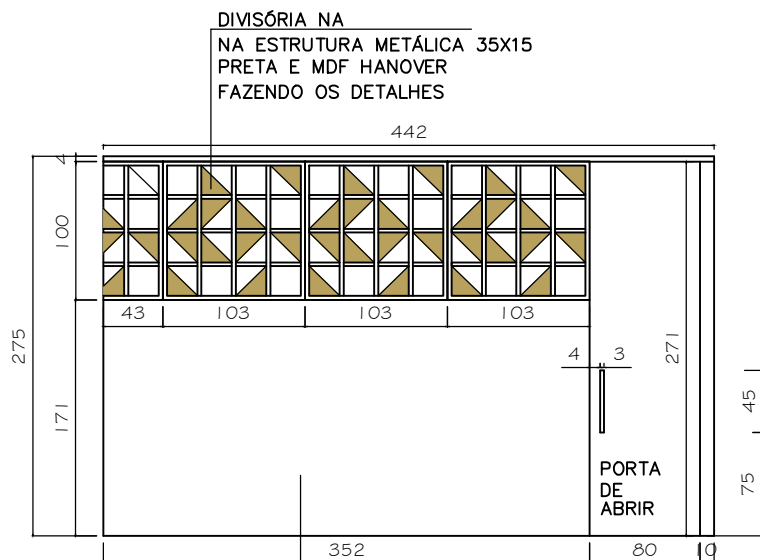

VISTA B
ESC. 1/50

DIVISÓRIA NO MDF DURATEX
GIANDUIA LINHA VELLUTO
COM PORTA DE ABRIR
E PUXADOR CAVA

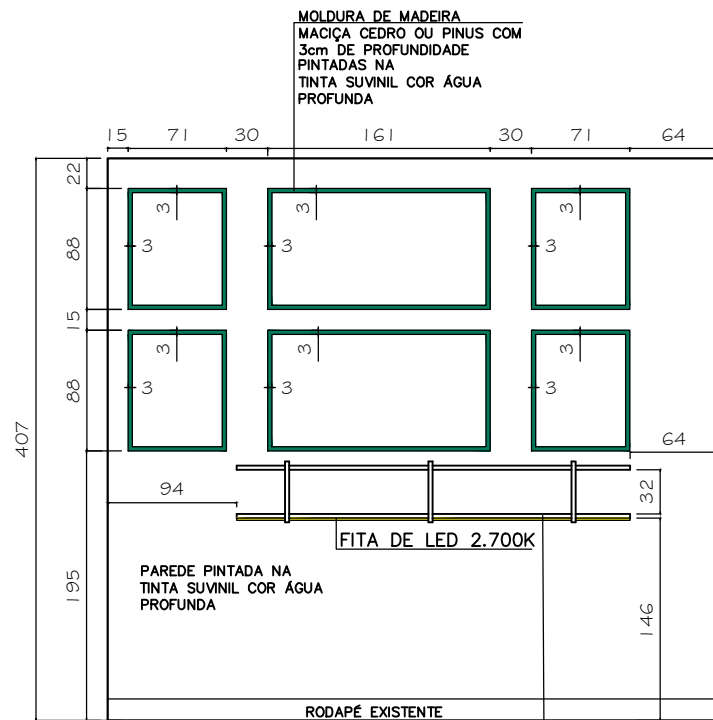

VISTA C
ESC. 1/50

PRATELEIRA NO MDF DURATEX
CARVALHO HANOVER
COM ESTRUTURA 35X15
METÁLICA PRETO
E FITA DE LED EMBUTIDA 2.700K

LEGENDA TINTA PAREDE



09/15

JUNHO / 2024

ARQUITETA: MAYRA SANTOS

08

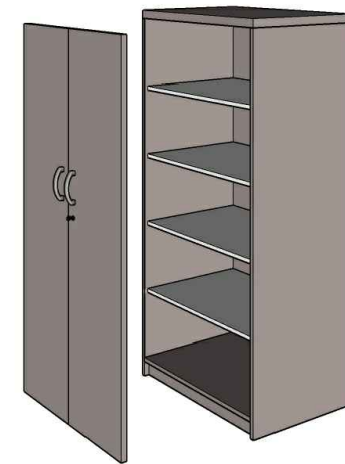
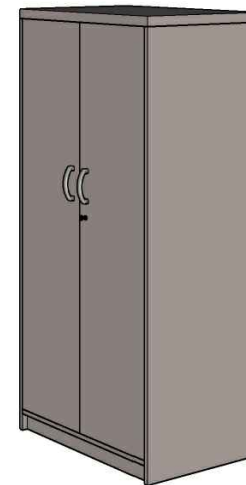
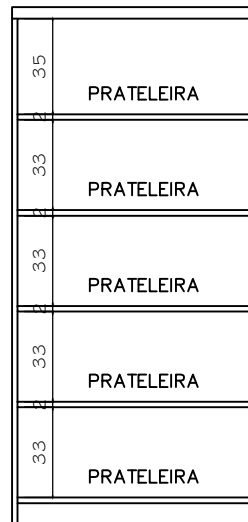
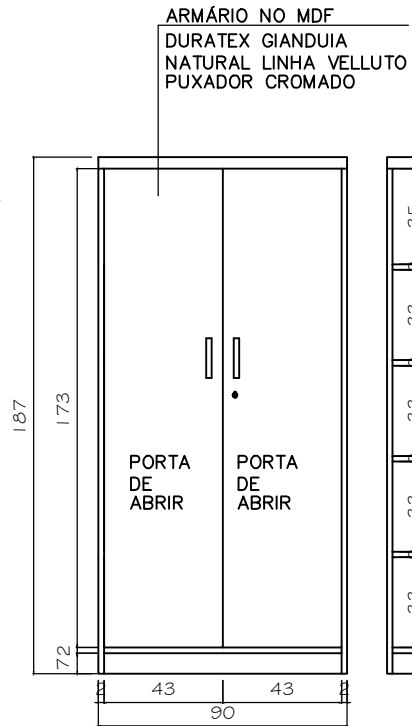
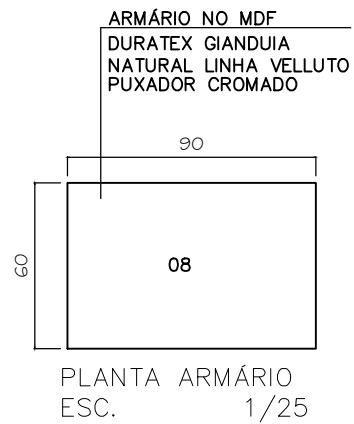

ARMÁRIO
IMAGEM 3D – ILUSTRATIVA

09

MESA NO MDF DURATEX
CARVALHO HANOVER
COM PÉS DE ESTRUTURA 30X50
METÁLICA PRETO

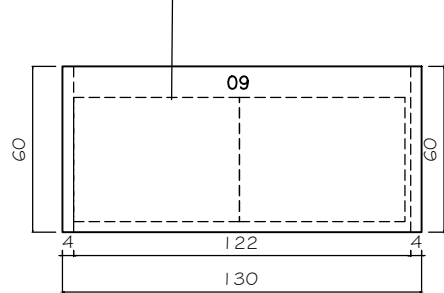

PLANTA MESA
ESC. 1/25

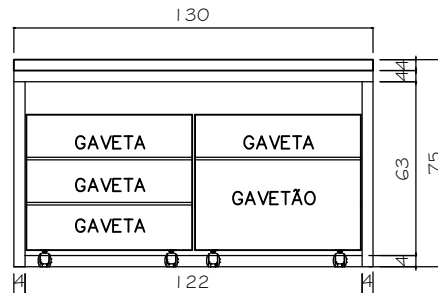

VISTA FRONTAL MESA
ESC. 1/25

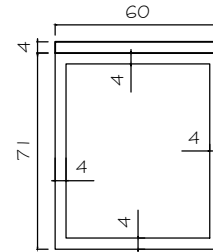

LATERAL DA
MESA
ESC. 1/25

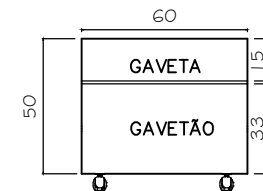

GAVETEIRO FRONTAL
ESC. 1/25

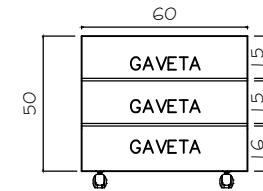

GAVETEIRO FRONTAL
ESC. 1/25



MESA LÍVIA
IMAGEM 3D – ILUSTRATIVA



MESA LÍVIA
IMAGEM 3D – ILUSTRATIVA

10

MESA NO MDF DURATEX
CARVALHO HANOVER
COM PÉS DE ESTRUTURA 30X50
METÁLICA PRETO

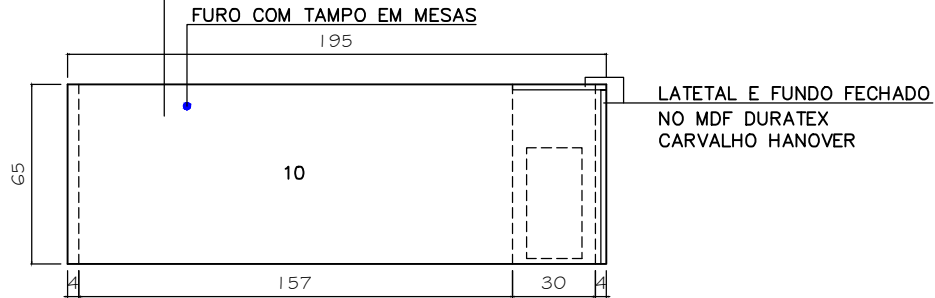

PLANTA MESA
ESC. 1/25

LATETAL E FUNDO FECHADO
NO MDF DURATEX
CARVALHO HANOVER

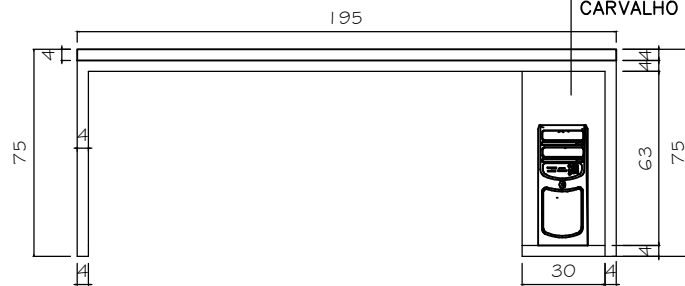

VISTA FRONTAL MESA
ESC. 1/25



MESA LÍVIA
IMAGEM 3D – ILUSTRATIVA

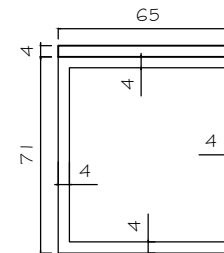

LATERAL DA
MESA
ESC. 1/25

11

PRATELEIRA NO MDF DURATEX
CARVALHO HANOVER
COM ESTRUTURA 35X15
METÁLICA PRETO

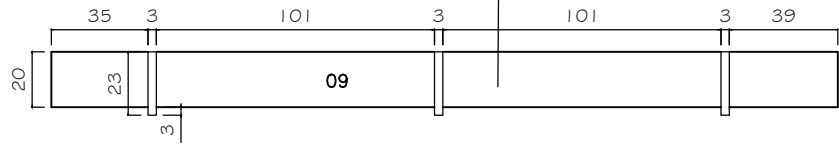

PLANTA PRATELEIRA SUSPensa
ESC. 1/25

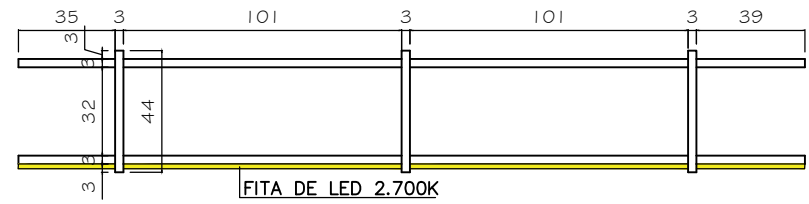

VISTA FRONTAL PRATELEIRA SUSPensa
ESC. 1/25



FITA DE LED 2.700K
EMBUTIDA NA PRATELEIRA



FITA DE LED DA PRATELEIRA
ESC. 1/5

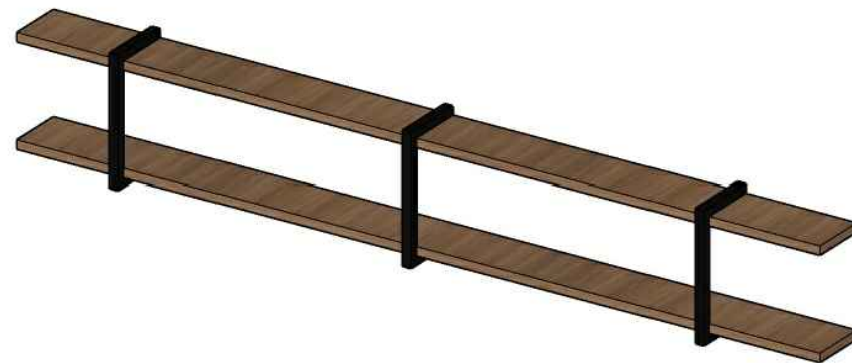

PRATELEIRAS SUSPensas
IMAGEM 3D - ILUSTRATIVA

12

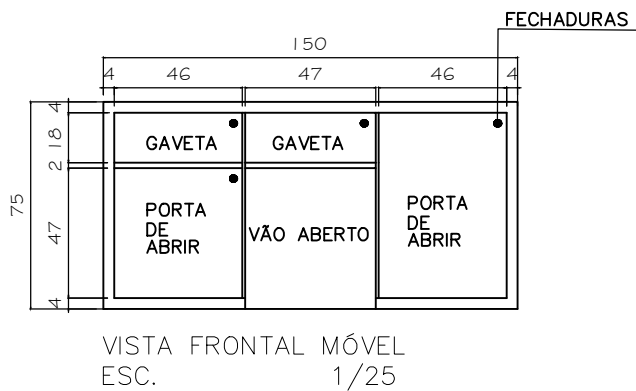
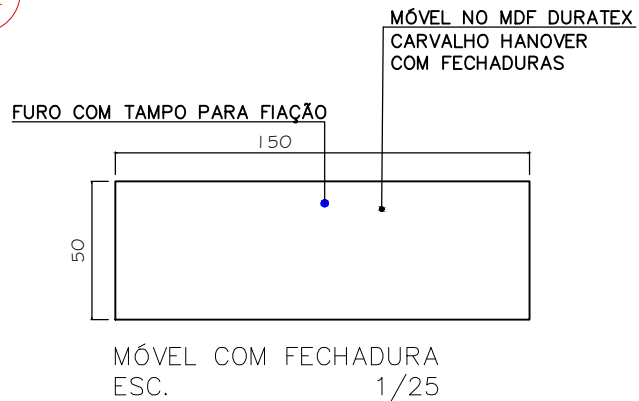

MÓVEL DE APOIO DO RETOPROJETOR
IMAGEM 3D – ILUSTRATIVA

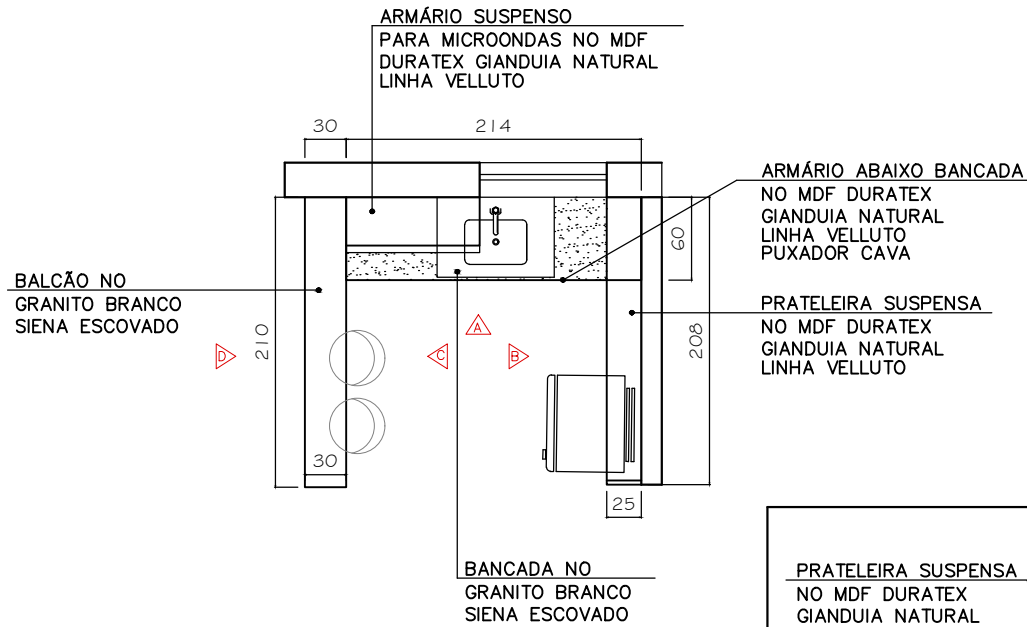

PLANTA COZINHA ESC. 1/50

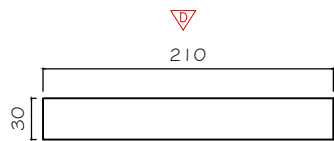

BALCÃO ESC. 1/50

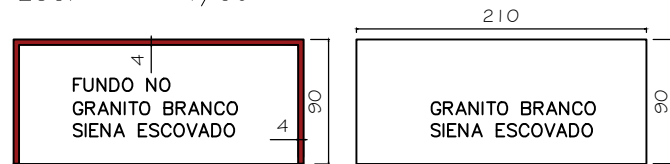

VISTA C ESC. 1/50

VISTA D ESC. 1/50

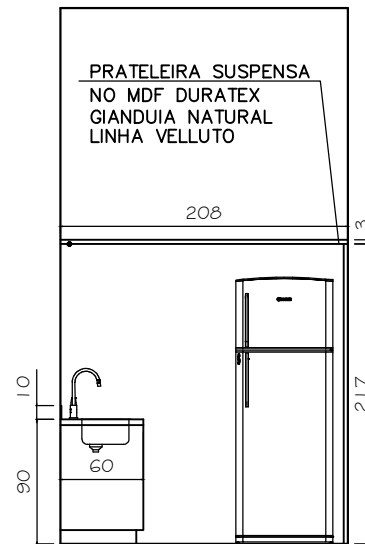

VISTA B ESC. 1/50

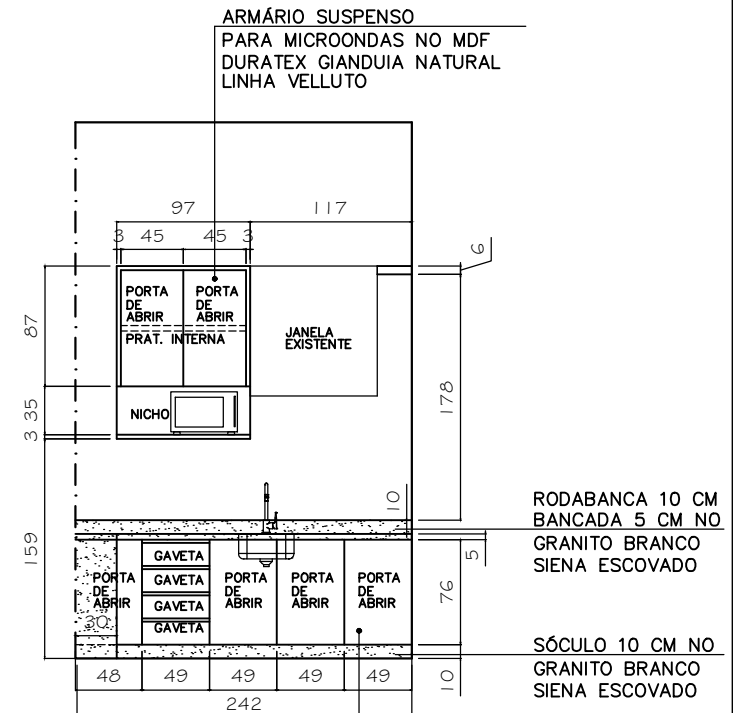

VISTA A ESC. 1/50

ARMÁRIO ABAIXO BANCADA NO MDF DURATEX GIANDUIA NATURAL LINHA VELLUTO PUXADOR CAVA

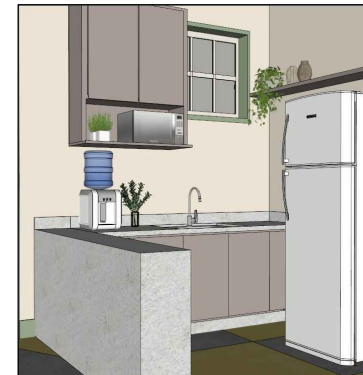

IMAGEM 3D - ILUSTRATIVA ARQUITETA: MAYRA SANTOS